

Vacuum pump (oil-lubricated)

Type 0160.3-IE2

Type 0250.3-IE2

	VP-0160.3-Europe-IE2
	VP-0250.3-Europe-IE2

	VP-0160.3-Multi-IE2
	VP-0250.3-Multi-IE2

	VP-0160.3-Brazil-IE2
	VP-0250.3-Brazil-IE2

Please read and pay attention



Albert Fezer Maschinenfabrik GmbH
Hauptstraße 37 – 39
D-73730 Esslingen
Tel: (0711) 3 60 09 – 0
Fax (07 11) 3 60 09-40
e-mail: [info @ fezer.com](mailto:info@fezer.com)
Internet: www.fezer.com
BA-Nr: 6.54.2.0079

Table of Contents

Preface	3	Checking the level	13
Technical Data	3	Topping up Oil	14
Product description	4	Checking the Colour of the Oil	14
Use	4	OilLife	14
Principle of operation.....	4	Oil and Oil Filter Change	14
Oil Circulation.....	5	Draining Used Oil.....	14
Cooling	5	Flushing the vacuum pump	14
Operational Options / Use of Optionally Available Equipment.....	5	Cleaning of the float valve	15
On/Off switch.....	5	Replacing the Oil Filter	15
Safety	5	Filling in Fresh Oil.....	15
Intended use	5	Exhaust Filter	15
Safety notes	5	Check during operation	15
Emission of Oil Mist	6	Assessment	15
Noise Emission	6	Change of the exhaust filters	15
Transport	6	Removingthe exhaustfilters	16
Transport in Packaging	6	Inserting the Exhaust Filters	16
Transport without Packaging	6	Gas ballast	16
Storage	6	Inletflange	16
Short-term Storage	6	Fan cover	16
Conservation	6	Motor cover.....	16
Commissioning after conservation	7	Overhaul	16
Installation and Commissioning	7	Removal from Service	17
Installation prerequisites	7	Temporary Removal from Service	17
Mounting Position and space	7	Recommissioning	17
Suction Connection	8	Dismantling and Disposal.....	17
Discharge connection	8	Troubleshooting	18
Electrical connection / Controls	9	Exploded drawing	23
Heat exchanger (water/ oil) (accessory)	9	Spare parts	24
Connecting cooling water	9	Wearing Parts Kits	25
Installation	10	Accessories	25
Mounting	10	Oil	26
Connecting electrically	10	EG-Declaration of Conformity	27
Connecting Lines/Pipes	10		
Filling Oil	11		
Recording of Operational Parameters	12		
Operation Notes	12		
Application	12		
Conveying Condensable Steams	12		
Maintenance	13		
Maintenance Schedule	13		
Monthly:	13		
Every6Months:	13		
Yearly:	13		
Every 500 - 2000 Operating hours (see "Oil Life").....	13		
Every 16000 Operating hours, at the latest after 4 Years:.....	13		
Checking the oil	13		

Preface

Congratulations on your purchase of the Fezer vacuum pump. With watchful observation of the field's requirements, innovation and steady development Fezer delivers modern vacuum and pressure solutions worldwide.

These operating instructions contain information for

- product description,
 - safety,
 - transport,
 - storage,
 - installation and commissioning,
 - maintenance,
 - overhaul,
 - troubleshooting and
 - spare parts
- of the vacuum pump.

For the purpose of these instructions, "handling" the vacuum pump means the transport, storage, installation, commissioning, influence on operating conditions, maintenance, troubleshooting and overhaul of the vacuum pump.

Prior to handling the vacuum pump these operating instructions shall be read and understood. If anything remains to be clarified please contact your Fezer representative! Keep these operating instructions and, if applicable, other pertinent operating instructions available on site.

Technical Data

0160.3-IE2	Europe		Multi				Brazil	
Suction capacity [m ³ /h]	160		160		190		190	
Suction capacity [l/s]	44,44		44,44		52,77			
Vacuum [mbar]	-995		-995		-995		-995	
Motor nominal rating [kW]	4		5,5		6,6			
Motor nominal speedl [min ⁻¹]	1460		1475		1765			
Frequency [Hz]	50		50		60		60	
Voltage [V]	230±10%	400±10%	190-208	380-415	220-230	440-460	220	380
Current consumption [A]	14,1	8,1	24,4	12,2	23,8	11,9		
Noise level [db (A)]	70		70		72		72	
Protective system	IP55		IP55		IP55		IP55	
Efficiency class	IE2		IE2		IE2		IE2	
Weight approx. [kgs]	160		160		160		160	
Oil quantity [l]	6,5		6,5		6,5		6,5	
Water vapour tolerance max. [hPa (=mbar)]	40		40		40		40	
Water vapour capacity [l/h]	2,5		2,5		2,8		2,8	
Operating temperature [°C]	64		64		66		66	
Ambient temperature range [°C]	see „Oil“							
Ambient pressure	Atmospheric pressure							

0250.3-IE2	Europe		Multi				Brazil	
Suction capacity [m ³ /h]	250		250		300		300	
Suction capacity [l/s]	69,44		69,44		83,33			
Vacuum [mbar]	-995		-995		-995		-995	
Motor nominal rating [kW]	5,5		5,5		7,5		7,5	
Motor nominal speedl [min ⁻¹]	1460		1475		1765		1765	
Frequency [Hz]	50		50		60		60	
Voltage [V]	400±10%	690±10%	190-208	380-415	220-230	440-460	220	380
Current consumption [A]								
Noise level [db (A)]	72		72		74		74	
Protective system	IP55		IP55		IP55		IP55	
Efficiency class	IE2		IE2		IE2		IE2	
Weight approx. [kgs]	195		195		195		195	
Oil quantity [l]	6,5		6,5		6,5		6,5	
Water vapour tolerance max. [hPa (=mbar)]	40		40		40		40	
Water vapour capacity [l/h]	4,5		4,5		5		5	
Operating temperature [°C]	80		80		81		81	
Ambient temperature range [°C]	see „Oil“							
Ambient pressure	Atmospheric pressure							



- a Suction connection
- b Gas discharge
- c Radial fan
- d Oil filter
- e Nameplate
- f Oil mist separator
- g Discharge valve
- h Mesh screen
- i Oil sight glass
- j Oil drain plug
- k Oil fill plug
- l Exhaust filter
- m Level switch
- n Rotor vanes
- o Rotor
- p Oil

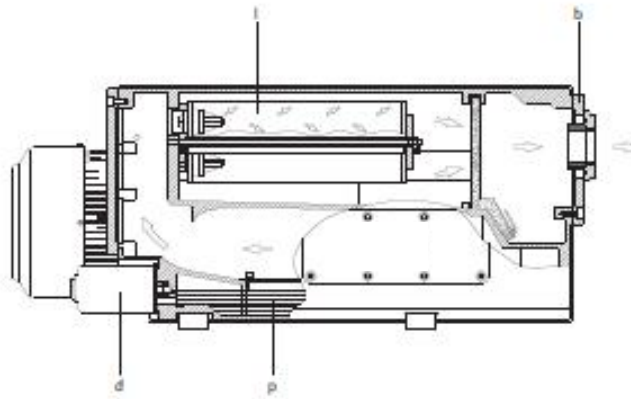
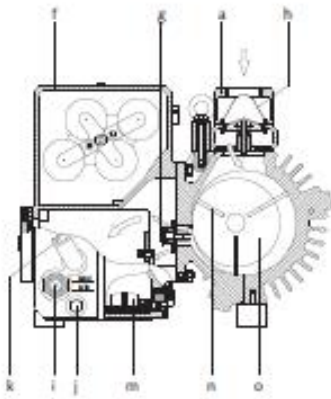

Product description

Use

The vacuum pump is intended for

of

- air and other dry, non-aggressive, non-toxic and non-explosive gases.

Conveying media with a higher density than air leads to an increased thermal and mechanical load on the vacuum pump and is permissible only after prior consultation with FEZER.

Max. allowed temperature of the inlet gas:

See "Oil, Ambient temperature range"

In case the vacuum pump is equipped with a gas ballast (optional), water vapour within the gas flow can be tolerated within certain limits (see "Installation and Commissioning, Operating Notes, Conveying Condensable Vapours"). The conveyance of other vapours shall be agreed upon with FEZER.

The vacuum pump is intended for the placement in a non-potentially explosive environment.

The vacuum pump is thermally suitable for continuous operation.

The vacuum pump is ultimate pressure proof.

Principle of operation

The vacuum pump works on the rotating vane principle.

A circular rotor (o,1 5) is positioned centrally on the shaft of the vacuum pump. The shaft of the vacuum pump is driven by the drive motor shaft by means of a flexible coupling.

The rotor (o, 15) rotates in an also circular, fixed cylinder(1), the centreline of which is offset from the centreline of the rotor such that the rotor and the inner wall of the cylinder almost touch along a line. Vanes (n,22), sliding in slots in the rotor, separate the space between the rotor and the cylinder into chambers. At any time gas is sucked in and at almost any time ejected. Therefore the vacuum pump works almost pulsation free.

In order to avoid the suction of solids, the vacuum pump is equipped with a mesh screen (h,261) in the suction connection.

In order to avoid reverse rotation after switching off, the vacuum pump is equipped with a non-return valve (251 -254).

NOTE: This valve shall not be used as a non-return valve or shut-off valve to the vacuum system and is no reliable means to prevent suction of oil into the vacuum system while the vacuum pump is shut down.

In case the vacuum pump is equipped with a gas ballast (optional):

Through the gas ballast valve (470-480) a small amount of ambient air is sucked into the pump chamber and compressed together with the process gas. This counteracts the accumulation of condensates from the process gas inside the vacuum pump (see also "Operation Notes").

Gas ballast version with ball valve:

The gas ballast line can be closed partially or completely by means of a ball valve (477).

In order to improve the operating characteristics the outlet of the pump chamber is equipped with a spring loaded valve (g,159).

Oil Circulation

The vacuum pump requires oil to seal the gaps, to lubricate the vanes(n,22) and to carry away compression heat.

The oil reservoir is located on the pressure side of the vacuum pump (i.e. high pressure) at the bottom of the bottom chamber of the oil separator (f,75).

The feed openings are located on the suction side of the vacuum pump (i.e. low pressure).

Forced by the pressure difference between pressure side and suction side oil is being drawn from the oil separator (f,75) through the oil supply lines and injected on the suction side.

Together with the sucked gas the injected oil gets conveyed through the vacuum pump and ejected into the oil mist separator (f,75). Oil that separates before the exhaust filter accumulates at the bottom of the bottom chamber of the oil separator (f,75).

Oil that is separated by the exhaust filter(l,120) accumulates at the bottom of the upper chamber of the oil separator (f,75).

The flow resistance of the exhaust filters (l,120) causes the inside of the exhaust filters (which is connected to be bottom chamber of the oil separator) to be on a higher pressure level than the outside of the ex-haust filters (i.e. the upper chamber of the oil separator). Because of the higher pressure in the bottom chamber it is not possible to let oil that drips off the exhaust filters simply flow down to the bottom chamber.

Therefore the oil that accumulates in the upper chamber is sucked by the level switch (m,194) through the oil return line (290) rightto the suction connection (250).

Cooling

The vacuum pump is cooled by

- the ambient air around the vacuum pump, including oil mist separator (f,75)
- the air flow from the fan wheel (400)
- the conveyed gas
- the air flow from the fan wheels (321,322) on the shaft of the vacuum pump

Operational Options / Use of Optionally Available Equipment

In order to facilitate the start of the pump, an offloading valve (optional) with an exhaust line can be installed.

To control the oil level in the oil mist separator, an oil level switch is mounted in the oil mist separator (as operational option).

In case of unfavourable temperature conditions, a heat exchanger (water-oil) can be mounted as a complementary cooling (optional).

To suck condensable vapours, a gas ballast valve (optional) can be installed in the cylinder cover at fan side. To increase the capacity of vapours, another gas ballast valve can be installed in the cylinder cover at the motor side. The valve can open or close the gas ballast during the operation of the pump.

In order to ensure the best ultimate pressure during the process, a solenoid valve (optional) can be installed before the gas ballast valve. The solenoid valve can be used as a purge at the end of the process.

On/Off switch

The vacuum pump comes without on/off switch. The control of the vacuum pump is to be provided in the course of installation

Safety

Intended use

DEFINITION: : For the purpose of these instructions, "handling" the vacuum pump means the transport, storage, installation, commissioning, influence on operating conditions, maintenance, troubleshooting and overhaul of the vacuum pump.

The vacuum pump is intended for industrial use. It shall be handled only by qualified personnel.

The allowed media and operational limits according to the "Product Description" and the "Installation Prerequisites" of the vacuum pump shall be observed both by the manufacturer of the machinery into which the vacuum pump is to be incorporated and by the operator.

The maintenance instructions shall be observed.

Prior to handling the vacuum pump these operating instructions shall be read and understood. If anything remains to be clarified please contact your FEZER representative!

Safety notes

The vacuum pump has been designed and manufactured according to the state-of-the-art. Nevertheless, residual risks may remain. These operating instructions inform about potential hazards where appropriate. Safety notes are tagged with one of the keywords DANGER, WARNING and CAUTION as follows:



DANGER

Disregard of this safety note will always lead to accidents with fatal or serious injuries.



WARNING

Disregard of this safety note may lead to accidents with fatal or serious injuries.



CAUTION

Disregard of this safety note may lead to accidents with minor injuries or property damage.

Emission of Oil Mist

The oil in the process gas is separated to the greatest possible extent, but not perfectly.



CAUTION

The non-OEM spares market offers exhaust filters that are geometrically compatible with Fezer - vacuum pumps, but do not feature the high retention capacity of genuine Fezer-exhaust filters.

Increased risk of damage to health.

In order to keep the emission on the lowest possible level only genuine Fezer-exhaustfilters shall be used.

The oil in the process gas is separated to the greatest possible extent, but not perfectly.



CAUTION

Aspiration of gas conveyed by the vacuum pump over extended periods can be harmful.

The room into which the gas conveyed by the vacuum pump is discharged must be sufficiently vented.

NOTE: The possibly sensible smell is not caused by droplets of oil, though, but either by gaseous process components or by readily volatile and thus gaseous components of the oil (particularly additives).

Noise Emission

For the sound pressure level in free field according to EN ISO 2151, see Technical Data.



CAUTION

The vacuum pump emits noise of high intensity.

Risk of damage to the hearing.

Persons staying in the vicinity of a non noise insulated vacuum pump over extended periods shall wear ear protection.

Transport

Transport in Packaging

Packed on a pallet the vacuum pump is to be transported with a forklift.

Transport without Packaging

In case the vacuum pump is bolted to a pallet or a base plate:

Remove the bolting between the vacuum pump and the pallet/base plate



CAUTION

Do not walk, work or stand under suspended loads..



CAUTION

Please check out the weight of the vacuum pump before lifting it up (see "Technical Data")

Use adequate lifting gear for this.

NOTE: The position of the eyebolt (391) fits to the centre of gravity of a vacuum pump incl. drive motor (400). If a vacuum pump without drive motor is to be lifted, attach another belt/rope at a suitable point.

◆ Attach lifting gear securely to the eyebolt (391) on the cylinder.

◆ Attach lifting gear to a crane hook with safety latch.

◆ Lift the vacuum pump with a crane hook.

In case the vacuum pump was bolted to a pallet:

◆ Remove the stud bolts from the rubber feet.



CAUTION

Tilting a vacuum pump that is already filled with oil can cause large quantities of oil to ingress into the cylinder.

Starting the vacuum pump with excessive quantities of oil in the cylinder will immediately break the vanes and ruin the vacuum pump.

Once the vacuum pump is filled with oil it shall not be lifted anymore.

◆ Prior to every transport make sure that the oil is drained

Storage

Short-term Storage

Version with gas ballast device with ball-cock:

◆ Make sure that the ball-cock (477) of the gas ballast device (470-480) is closed

◆ Make sure that the suction connection/gas inlet and the gas discharge/pressure connection are closed (leave the provided plugs in)

◆ Store the vacuum pump

– if possible in original packaging,

– indoors,

– dry,

– dustfree

– vibration free

Conservation

In case of adverse ambient conditions (e.g. aggressive atmosphere, frequent temperature changes) conserve the vacuum pump immediately. In case of favourable ambient conditions conserve the vacuum pump if a storage of more than 3 months is scheduled.

During the factory tests, the vacuum pump inside has been completely in contact with oil. In case of favourable ambient conditions, it is not necessary to the pump with conservation oil. In case of unfavourable storage conditions, the vacuum pump draining with conservation oil is advised. If anything remains to be clarified please contact your FEZER representative!

- ◆ Make sure that the oil is drained (see Maintenance, Oil Change, Draining Used Oil)

Version with gas ballast device with ball-cock:

- ◆ Make sure that the ball-cock (477) of the gas ballast device (470-480) is closed
- ◆ Fill in conservation oil in small quantities by the suction connection, observe the oil type and the given quantity in the tables below:

Oil Type
Corex HLP-D 68, P/N 0831 512 575 (or a conservation oil from same quality)

Pump type	Conservation oil quantity
0160.3	2 litres
0250.3	

- ◆ Wrap PTFE-tape around the thread of the suction connection
- ◆ Firmly close the suction connection with a plug.



CAUTION

Operation with a gas discharge/pressure connection closed will damage the vacuum pump.

Make sure that the gas discharge is open.



CAUTION

During operation the surface of the vacuum pump may reach temperatures of more than 70°C.

Risk of burns!

Do not touch the hot housing.

- ◆ Electrically connect the vacuum pump (see "Installation and Commissioning, Installation, Connect Electrically")
- ◆ Let the vacuum pump run for at least half an hour
- ◆ Switch the vacuum pump off
- ◆ Drain the conservation oil (see "Maintenance, Oil Change, Draining Used Oil")
- ◆ Wrap PTFE-tape around the thread of a plug
- ◆ Firmly insert the plug into the discharge connection
- ◆ Make sure that all ports are firmly closed ; seal all ports that are not with PTFE-tape, gaskets or o-rings with adhesive tape.

NOTE: VCI stands for "Volatile Corrosion Inhibitor". VCI-products (film, paper, cardboard, foam) evaporate a substance that molecular thickness on the packed good and by its electro-chemical properties effectively suppresses corrosion on metallic surfaces. However, VCI-products may attack the surfaces of

plastics and elastomers. Seek advice from your local packaging dealer! Fezer uses CORTEC VCI 126 R film forthe overseas packaging of large equipment.

- ◆ Wrap the vacuum pump in VCI film
- ◆ Store the vacuum pump
 - if possible in original packing,
 - indoors,
 - dry,
 - dust free and
 - vibration free

Repeat the conservation process after 12 months of immobilization



CAUTION

Before a new conservation process or re-installation of the vacuum pump, make sure that the gasket, plug or adhesive tape from the discharge connection are removed.

Commissioning after conservation

- ◆ Make sure that the gasket, plug or adhesive tape are removed from the ports
- ◆ Commission the vacuum pump as described in the chapter "Installation and Commissioning"

**Installation and
Commissioning
Installation prerequisites**



CAUTION

In case of non-compliance with the installation prerequisites, particularly in case of insufficient cooling:

Risk of damage or destruction of the vacuum pump and adjoining plant components!

Risk of injury!

The installation prerequisites must be complied with.

Make sure that the integration of the vacuum pump is carried out such that the essential safety requirements of the Machine Directive 2006/42/EC are complied with (in the responsibility of the designer of the machinery into which the vacuum pump is to be incorporated; see also the note in the EC-Declaration of Conformity)

Mounting Position and space

- ◆ Make sure that the environment of the vacuum pump is not potentially explosive
- ◆ Make sure that the following ambient conditions will be complied with:
 - Ambient temperature: see "Oil"
 - Ambient pressure: atmospheric
- ◆ If the vacuum pump is installed in a colder environment than allowed with the oil used:

- ◆ Fit the vacuum pump either with an oil sump heater (on request) or fit the vacuum pump with a temperature switch and control the vacuum pump in such a way that it will start automatically when the oil sump temperature drops below the allowable temperature
- Make sure that the environmental conditions comply with the protection class of the drive motor (according to the nameplate)
- Make sure that the vacuum pump will be placed or mounted horizontally
- Make sure that the base for placement / mounting base is even
- Make sure that the vacuum pump can neither inadvertently nor intentionally be stepped on and cannot be used as a support for heavy objects
- Make sure that the vacuum pump cannot be hit by falling objects
- Make sure that in order to warrant a sufficient cooling there will a clearance of minimum 0,5 m between the fan hood and nearby walls
- Make sure that no temperature sensitive parts (plastics, wood, cardboard, paper, electronics) will touch the surface of the vacuum pump
- Make sure that the installation space or location is vented such that a sufficient cooling of the vacuum pump is warranted



CAUTION

During operation the surface of the vacuum pump may reach temperatures of more than 70°C.

Risk of burns!

- ◆ Make sure that the vacuum pump will not be touched inadvertently during operation, provide a guard if appropriate
- ◆ Make sure that the oil sight glass (i,83) will remain easily accessible

If the oil change is meant to be performed on location:

- ◆ Make sure that the oil drain port (j,95), the oil filter (d,100) and the oil fill port (k,88) will remain easily accessible
- ◆ Make sure that enough space will remain for the removal and the reinsertion of the exhaust filter(s) (l,120)

Suction Connection



CAUTION

Do not put hands into the inlet aperture.

Risk of body damage!



CAUTION

Intruding foreign objects or liquids can destroy the vacuum

In case the inlet gas can contain dust or other foreign solid particles:

- ◆ Make sure that a suitable filter (5 micron or less) is installed upstream the vacuum pump

- ◆ Make sure that the suction line fits to the suction connection/gas inlet (a,260) of the vacuum pump
- ◆ Make sure that the gas will be sucked through a vacuum-tight flexible hose or a pipe

In case of using a pipe:

- ◆ Make sure that the pipe will cause no stress on the vacuum pump's connection, if necessary use bellows
- ◆ Make sure that the line size of the suction line over the entire length is at least as large as the suction connection/gas inlet (a,260) of the vacuum pump

In case of very long suction lines it is prudent to use larger line sizes in order to avoid a loss of efficiency. Seek advice from your Fezer representative

If two or more vacuum pumps work on the same suction line, if the volume of the vacuum system is large enough to suck back oil or if the vacuum shall be maintained after switching off the vacuum pump:

- ◆ Provide a manual or automatic operated valve (= non-return valve) in the suction line

(the non-return valve that is installed inside the suction connection is not meant to be used for this purpose!)

If the vacuum pump is planned to be used for the suction of gas that contains limited quantities of condensable vapour

- ◆ Provide a shut-off valve, a drip-leg and a drain valve in the suction line, so that condensates can be drained from the suction line

- ◆ Make sure that the suction line does not contain foreign objects, e.g. welding scales

Discharge connection



CAUTION

Do not put hands into the inlet aperture.

Risk of body damage!

The following guidelines for the discharge line do not apply, if the aspirated air is discharged to the environment right at the vacuum pump.



CAUTION

The discharged air contains small quantities of vacuum oil.

Staying in vacuum oil contaminated air bears a risk of damage to health.

If air is discharged into rooms where persons stay, sufficient ventilation must be provided for.

- ◆ Make sure that the discharge line fits to the gas discharge connection (b,1 53) of the vacuum pump

In case of using a pipe:

- ◆ Make sure that the pipe will cause no stress on the discharge connection, if necessary use bellows
- ◆ Make sure that the line size of the discharge line over the entire length is at least as large as the gas discharge connection (b,153) of the vacuum pump

In case of very long discharge lines it is prudent to use larger line sizes in order to avoid a loss of efficiency and an overload of the vacuum pump. Seek advice from your FEZER representative-

Make sure that the discharge line either slopes away from the vacuum pump or provide a liquid separator or a drip leg with a drain cock, so that no liquids can back up into the vacuum pump.



WARNING

Discharge lines made from non-conducting material can build up static charge.

Static discharge can cause explosion of potentially existing oil mist

The discharge line must be made of conducting material or provisions must be made against static discharge

Electrical connection / Controls

- ◆ Make sure that the stipulations acc. to the EMC-Directive **2004/108/EC** and Low-Voltage-Directive **2006/95/EC** as well as the EN-standards, electrical and occupational safety directives and the local or national regulations, respectively, are complied with (this is in the responsibility of the designer of the machinery into which the vacuum pump is to be incorporated; see also the note in the EC-Declaration of Conformity).
- ◆ Make sure that the power supply is compatible with the data on the nameplate of the drive motor (400)
- ◆ Make sure that an overload protection according to EN 60204-1 is provided for the drive motor
- ◆ Make sure that the drive of the vacuum pump will not be affected by electric or electromagnetic disturbance from the mains; if necessary seek advice from the FEZER service

In case of mobile installation::

Provide the electrical connection with grommets that serve as strain-relief

Heat exchanger (water/ oil) (accessory)

It is possible to install a heat exchanger (water/ oil) (accessory) as a complementary cooling when we have applications with unfavourable ambient conditions.

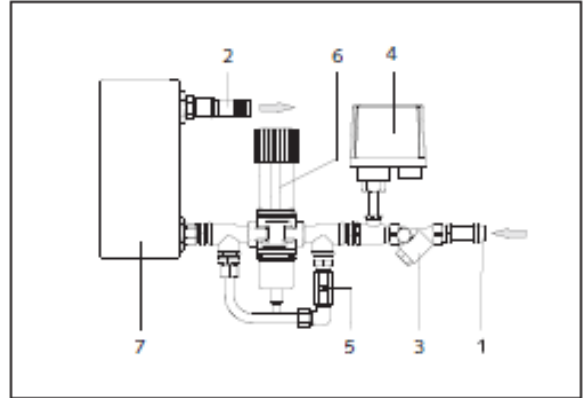
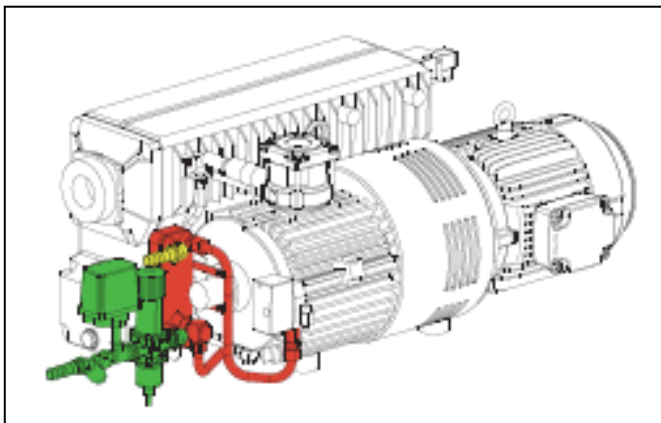

- 1 Cooling water inlet
- 2 Cooling water outlet
- 3 Filter
- 4 Pressure switch
- 5 Ball valve (Bypass)
- 6 Thermostatic valve
- 7 Heat exchanger (water/ oil)

Connecting cooling water

The cooling water connection can be made with flexible hoses or tubes.

The cooling water outlet must be without pressure.

Make sure that the cooling water fulfills the following requirements:

- Temperature: 5 – 35°C
- Overpressure: 2 – 6 bar (relative)
- Water hardness: <5° dGH

Note: 1° (german degree = 1° dGH) = 1,78° (french degree) = 1,25 e (English degree) = 17,9 mg/kg CaCO₃ (American hardness)

- Make sure that the cooling water is neutral and clean
- Make sure that the cooling water outlet is unpressurised

Minimum water flow:

- 0160.3 to 0250.3 = 2,5l/min.

Default adjustment of the instruments:

- Valve thermostatic (6) = adjust to Position 2 (approximative oil temperature of 75°C)
- Inlet water pressure switch (4) = 2 bar

Installation

Mounting

- ◆ Make sure that the 'Installation Prerequisites' are complied with
- ◆ Set down or mount the vacuum pump at its location

Connecting electrically



WARNING

Risk of electrical shock, risk of damage to equipment.

Electrical installation work must only be executed by qualified personnel that knows and observes the following regulations:

- IEC 364 or CENELEC HD 384 or DIN VDE 0100, respectively,
- IEC-Report 664 or DIN VDE 0110,
- BGV A2 (VBG 4) or corresponding national accident prevention regulation.



CAUTION

The connection schemes given below are typical. Depending on the specific order or for certain markets deviating connection schemes may apply.

Risk of damage to the drive motor!

The inside of the terminal box shall be checked for drive motor connection instructions/schemes.

- ◆ Electrically connect the drive motor (400)
- ◆ Connect the protective earth conductor
- ◆ Delta connection (Low voltage):

Delta connection (Low voltage):

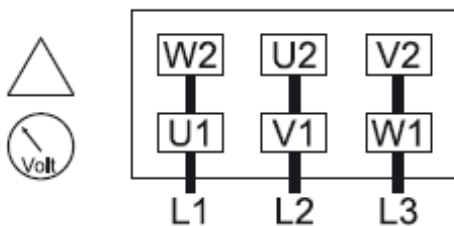

Star connection (High voltage):

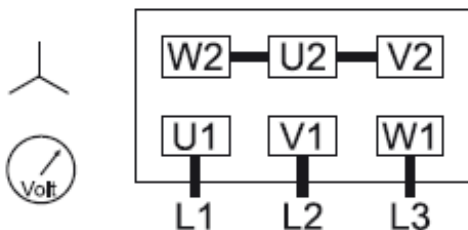

Star connection, multi-voltage motor (Low voltage):

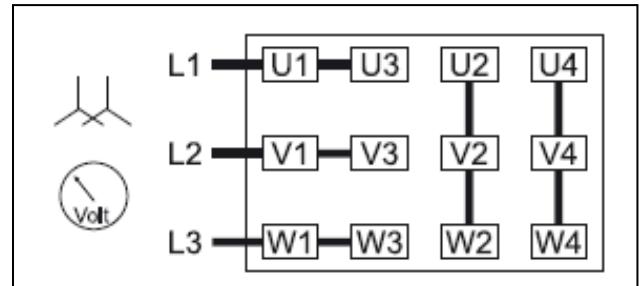

Delta connection, multi-voltage motor (Middle voltage):

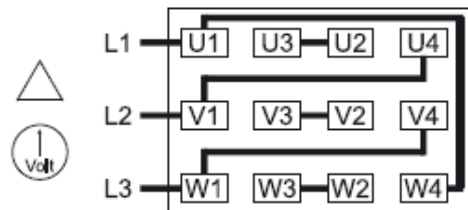

Star connection, multi-voltage motor (High voltage):

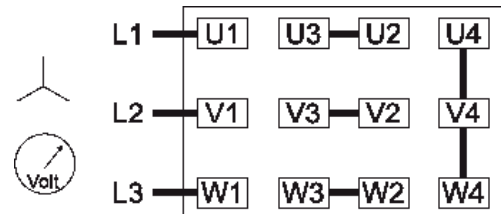



CAUTION

Operation in the wrong direction of rotation can destroy the vacuum pump in shorttime. .

Risk of explosion!

Prior to starting-up it must be made sure that the vacuum pump is operated in the proper direction..

- ◆ Determine the intended direction of rotation with the arrow
- ◆ "Bump" the drive motor
- ◆ Watch the fan wheel of the drive motor (400) and determine the direction of rotation just before the fan wheel stops

If the rotation of the fan wheel must be changed:

- ◆ Switch any two of the drive motor wires in the terminal box

Connecting Lines/Pipes

In case the suction line is equipped with a shut-off valve:

- ◆ Connect the suction line
- ◆ Connect the discharge line

Installation without discharge line:

- ◆ Make sure that the gas discharge (b,153) is open
- ◆ Make sure that all provided covers, guards, hoods etc. are mounted

- ◆ Make sure that cooling air inlets and outlets are not covered or obstructed and that the cooling air flow is not affected adversely in any other way

Filling Oil

In case the vacuum pump was treated with conservation oil:

Drain the remainders of conservation oil and top up oil (see "Maintenance/Oil and Oil Filter Change")



CAUTION

The vacuum pump is shipped without oil.

Operation without oil will ruin the vacuum pump in short time.

Prior to commissioning it must be made positively sure that oil is filled in.

The vacuum pump is delivered without oil (oil specification see "Oil").

Only oils according to DIN 51506, lubricating oil group VC must be used. Using the correct lubricant has a determining on the end pressure (the 0,1 hPa ultimate pressure is obtained with the use of VMH 100 oil type).

The application of the vacuum pump will definite the oil to be used.



CAUTION

A change of mineral oil by a synthetic oil needs a special procedure.

If the mineral oil (VM 032, VM 068, VM 100, VMH 100) has to be exchanged for synthetic oil (VS 100, VE 101), a specific procedure must be applied. This procedure is available near all the FEZER service companies.

- Keep approximately 6,5 litres oil according to the table "Oil" ready:

NOTE: The amount given in these operating instructions is a guide. The oil sight glass (i,83) indicates the actual amount to be filled in.



CAUTION

Before changing the oil type, compatibility shall be checked and, if necessary, the pump be flushed.



CAUTION

In case the vacuum pump has potentially been treated with conservation oil.

Synthetic oils (except for oils based on poly-a-olefin) are incompatible with mineral oils and conservation oils.
Risk of foaming leading to destruction of the vacuum pump.



CAUTION

Filling oil through the gas inlet (a,260) will result in breakage of the vanes (n,22) and destruction of the vacuum pump.

Oil may be filled through the oil fill port only (k,88).



CAUTION

During operation the oil separator is filled with hot, pressurised oil mist.

Risk of injury from hot oil mist with open oil fill port. Risk of injury if a loosely inserted oil fill plug is ejected. Remove

the oil fill plug only if the vacuum pump is stopped.

The vacuum pump must only be operated with the oil fill plug firmly inserted.

- ◆ Remove the oil fill plug (k,88)
- ◆ Filling oil according to the values set in the table "Oil"
- ◆ Make sure that the level is between the MIN and the MAX-markings of the oil sight glass (i,83)
- ◆ Make sure that the seal ring (89) is inserted into the oil fill plug (k,88) and undamaged, replace if necessary
- ◆ Firmly reinsert the oil fill plug (k,88) together with the seal ring (89)

NOTE: Starting the vacuum pump with cold oil is made easier when at this very moment the suction line is neither closed nor covered with a rubber mat.

- ◆ Switch on the vacuum pump

In case the suction line is equipped with a shut-off valve:

- ◆ Close the shut-off valve

In case the suction line is not equipped with a shut-off valve:

- ◆ Cover the suction connection with a piece of rubber mat (a,260)
- ◆ Let the vacuum pump run for a few minutes
- ◆ Shut down the vacuum pump and wait a few minutes

- ◆ Make sure that the level is between the MIN and the MAX-markings of the oil sight glass (i,83)

In case the level has fallen below the MIN-marking of the oil sight glass:

- ◆ Top-up oil

In case the suction line is equipped with a shut-off valve:

- ◆ Open the shut-off valve

In case the suction line is not equipped with a shut-off valve:

- ◆ Remove the suction connection with a piece of rubber mat

Recording of Operational Parameters

As soon as the vacuum pump is operated under normal operating conditions:

- Measure the drive motor current and record it as reference for future maintenance and troubleshooting work

Version with exhaust filter pressure gauge

- Read the scale of the exhaust filter pressure gauge and record it as reference for future maintenance and troubleshooting work

Operation Notes

Application



CAUTION

The vacuum pump is designed for operation under the conditions described below.

In case of disregard risk of damage or destruction of the vacuum pump!

Risk of Injury!

The vacuum pump must be operated under the conditions described below.

The vacuum pump is designed for

- the suction

of

- air and other dry, non-aggressive, non-toxic and non-explosive gases

Conveying media with a higher density than air leads to an increased thermal and mechanical load on the vacuum pump and is permissible only after prior consultation with FEZER

Max. allowed temperature of the inlet gas:

See "Oil, Ambient temperature range"

In case the vacuum pump is equipped with a gas ballast (optional) water vapour within the gas flow can be tolerated within certain limits (see "Installation and Commissioning, Operating Notes, Conveying Condensable Vapours"). The conveyance of other vapours shall be agreed upon with Fezer.

The vacuum pump is made for the intended use in potentially explosive areas

The vacuum pump is thermally suitable for continuous operation.

The vacuum pump is ultimate pressure proof.



CAUTION

During operation the surface of the vacuum pump may reach temperatures of more than 70 °C.

Risk of burns!

The vacuum pump shall be protected against contact during operation.



CAUTION

The discharged air contains small quantities of vacuum oil.

Staying in vacuum oil contaminated air bears a risk of damage to health.

If air is discharged into rooms where persons stay, sufficient ventilation must be provided for.



CAUTION

The vacuum pump emits noise of high intensity.

Risk of damage to the hearing.

Persons staying in the vicinity of a non noise insulated vacuum pump over extended periods shall wear ear protection.

- ◆ Make sure that all provided covers, guards, hoods etc. are mounted
- ◆ Make sure that protective devices will not be disabled.
- Make sure that cooling air inlets and outlets are not covered or obstructed and that the cooling air flow is not affected adversely in any other way
- ◆ Make sure that the "Installation Prerequisites" (see "Installation Prerequisites and Commissioning") are complied with and will remain complied with, particularly that a sufficient cooling will be ensured.

Conveying Condensable Steams



CAUTION

Residual condensates dilute the oil, deteriorate its lubricating properties and can cause a jam of the rotor.

Apply a suitable operating method to make sure that no condensates remain in the vacuum pump.

In order to use the vacuum pump for the conveyance of condensable vapours, the vacuum pump must be equipped with shut-off valve in the suction line and with a gas ballast valve.

The quantity of condensable steams are indicated in the table "Technical Data".

Version with gas ballast device with ball-cock:

- ◆ Make sure that the ballast valve (477) is open and will remain open during operation

Version with gas ballast device with solenoid valve:

Make sure that the solenoid valve is closed.

NOTE: In the case of an operation with a gas ballast device with a solenoid valve, this one opens at the start of the vacuum pump in starconnection, this in order to discharge the motor. With the existing connection between the oil separator and the inlet flange, the air flow is assured.

The solenoid valve is closed when the motor passes in phase delta and the vacuum can thus be obtained.

- ◆ - Close the shut-off valve in the suction line
- ◆ Operate the vacuum pump with the shut-off valve in the suction line closed for approx. half an hour, so that the operating temperature will rise to approx. 75°C

At process start:

- ◆ Open the shut-off valve in the suction line

At process end:

- ◆ Close the shut-off valve in the suction line
- ◆ Operate the vacuum pump for another approx. half an hour

Maintenance



WARNING

In case the vacuum pump conveyed gas that was contaminated with foreign materials which are dangerous to health, harmful material can reside in filters.

Danger to health during inspection, cleaning or replacement of filters.

Danger to the environment.

Personal protective equipment must be worn during the handling of contaminated filters.

Contaminated filters are special waste and must be disposed of separately in compliance with applicable regulations.



CAUTION

During operation the surface of the vacuum pump may reach temperatures of more than 70°C.

Risk of burns!

- ◆ Prior to action that requires touching of the vacuum pump, let the vacuum pump cool down.

In case of oil draining:

- ◆ Let the vacuum pump cool down for no more than 20 minutes
- ◆ Prior to disconnecting connections make sure that the connected pipes/lines are vented to atmospheric pressure

Maintenance Schedule

NOTE: The maintenance intervals depend very much on the individual operating conditions. The intervals given below shall be considered as starting values which should be shortened or extended as appropriate. Particularly heavy duty operation, such like high dust loads in the environment or in the process gas, other contaminations or ingress of process material, can make it necessary to shorten the maintenance intervals significantly.

Monthly:

- ◆ Make sure that the vacuum pump is shut down and locked against inadvertent start up
- ◆ Check the level and the colour of the oil (see "Checking the Oil")
- ◆ Check the vacuum pump for oil leaks - in case of leaks have the vacuum pump repaired (Fezer service)
- ◆ Check the function of the exhaust filters (l,120) (see "Exhaust Filters")

In case an inlet air filter is installed:

- ◆ Check the inlet air filter, if necessary clean (with compressed air) or replace

In case of operation in a dusty environment:

- ◆ Make sure that the housing is free from dust and dirt, clean if necessary (see "Every 6 Months:")

Every 6 Months:

- ◆ Make sure that the vacuum pump is shut down and locked against inadvertent start up
- ◆ Make sure that the housing is free from dust and dirt, clean if necessary
- ◆ Clean the fan cowlings, fan wheels, ventilation protection screen and coolingfins

Yearly:

- ◆ Make sure that the vacuum pump is shut down and locked against inadvertent start up
- ◆ Replace the exhaust filters (l,120) (see "Exhaust filters")

In case an inlet filter is installed:

- ◆ Clean (with compressed air) or replace the inlet air filter
- ◆ Check the inlet screen (h, 261), clean if necessary

Every 500 - 2000 Operating hours (see "Oil Life")

- ◆ Change the oil, replace the oil filter(s) (d,100) and clean the float valve (m,194) (see "Oil and Oil Filter Change")

Every 16000 Operating hours, at the latest after 4 Years:

- ◆ Have a major overhaul on the vacuum pump (FEZER service)

Checking the oil

Checking the level

- ◆ Make sure that the vacuum pump is shut down and locked against inadvertent start up
- ◆ Make sure that the oil has collected at the bottom of the oil separator (f,75)
- ◆ Read the level on the sight glass (i,83)

In case the level has dropped underneath the MIN-marking:

- ◆ Top up oil (see "Topping up Oil")

In case the level exceeds the MAX-marking:

- ◆ Check the dilution with condensates.
- ◆ Change the oil (see "Change the oil")

If appropriate retrofit a gas ballast (FEZER Service) and observe the chapter "Operating Notes, Conveying Condensable Vapours"

Topping up Oil

NOTE: Under normal conditions there should be no need to top up oil during the recommended oil change intervals. A significant level drop indicates a malfunction (see "Troubleshooting").

NOTE: During operation the exhaust filter gets saturated with oil. It is therefore normal that the oil level will drop slightly after replacement of the exhaust filter.



CAUTION

Filling oil through the suction connection/gas inlet (a,260) will result in breakage of the vanes (n,22) and destruction of the vacuum pump.

Oil may be filled through the oil fill port only (k,88).



CAUTION

During operation the oil separator is filled with hot, pressurised oil mist.

Risk of injury from hot oil mist with open oil inlet plug (k,88). Remove the oil inlet port (k,88) only the vacuum pump is stopped.

The vacuum pump must only be operated with the oil fill plug (k,88) firmly inserted.

- ◆ Make sure that the vacuum pump is shut down and locked against inadvertent start up
- ◆ Remove the oil fill plug (k,88)
- ◆ Top up oil until the level reaches the middle of the oil sight glass (i,83)
- ◆ Make sure that the level is between the MIN and the MAX-markings of the oil sight glass (i,83)
- ◆ Make sure that the sealing seat (89) on the oil fill plug (k,88) is undamaged, if necessary replace the oil fill plug.
- ◆ Firmly reinsert the oil fill plug (k,88) with its sealing seat (89)

Checking the Colour of the Oil

NOTE: The oil should be light, either transparent, a little foamy or a little tarnished. A milky discolouration that does not vanish after sedation of the oil indicates contamination with foreign material. Oil that is either contaminated with foreign material or burnt must be changed (see "Oil Change").

Oil Life

The oil life depends very much on the operating conditions. A clean and dry air stream and operating temperatures below 100°C are ideal. Under these conditions the oil and the oil filter shall be changed every 2000 operating hours or after half a year.

Under very unfavourable operating conditions the oil life can be less than 500 operating hours. Extremely short life times indicate malfunctions (see "Troubleshooting") or unsuitable operating conditions, though

If there is no experience available with regard to the oil life under the prevailing operation conditions, it is recommended to have an oil analysis carried out every 500 operating hours and establish the change interval accordingly.

Oil and Oil Filter Change



WARNING

In case the vacuum pump conveyed gas that was contaminated with harmful foreign material the oil will be contaminated with harmful material.

Danger to health during the changing of contaminated oil.

Danger to the environment.

Personal protective equipment must be worn during the changing of contaminated oil.

Contaminated oil is special waste and must be disposed of separately in compliance with applicable regulations.

Draining Used Oil

NOTE: After switching off the vacuum pump at normal operating temperature wait no more than 20 minutes before the oil is drained.

- ◆ Make sure that the vacuum pump is shut down and locked against inadvertent start up
- ◆ Make sure that the vacuum pump is vented to atmospheric pressure
- ◆ Put a drain tray underneath the oil drain port (j,95)
- ◆ Remove the oil drain plug (j,95)
- ◆ Drain the oil

When the oil stream dwindles:

- ◆ Close the oil drain plug (j,95)
- ◆ Switch the vacuum pump on for a few seconds
- ◆ Make sure that the vacuum pump is shut down and locked against inadvertent start up
- ◆ Remove the oil drain plug
- ◆ Make sure that the sealing seat on the oil drain plug is undamaged, if necessary replace the oil drain plug
- ◆ Firmly reinsert the oil drain plug
- ◆ Dispose of the used oil in compliance with applicable regulations

Flushing the vacuum pump



WARNING

Degraded oil can choke pipes and coolers.

Risk of damage to the vacuum pump due to insufficient lubrication.

Risk of explosion due to overheating.

If there is a suspicion that deposits have gathered inside the vacuum pump the vacuum pump shall be flushed.

- ◆ Make sure that all the used oil is drained
- ◆ Make sure that the used oil filter (d,100) is still in place
- ◆ Create 6,5 litres of flushing agent from 50 percent oil and 50 percent paraffin or diesel fuel/fuel oil.
- ◆ Make sure that the oil drain plug (j,95) is reinsert correctly.

- ◆ Remove the oil fill plug (k,88)
- ◆ Fill in the flushing agent
- ◆ Firmly reinsert the oil fill plug (k,88) with its sealing seat (89)
- ◆ Close the suction line
- ◆ Run the vacuum pump for at least half an hour
- ◆ Drain the flushing agent and dispose of it in compliance with applicable regulations

NOTE: Due to the use of paraffin and even more in case of using Diesel fuel/fuel oil, unpleasant odour can occur after recommissioning. If this is a problem, Diesel fuel/fuel oil should be avoided and the vacuum pump be run at idle in a suitable place until the unpleasant odour vanishes.

Cleaning of the float valve

- ◆ Make sure that all the entire used oil is drained
- ◆ Loosen the 2 screws (247) and remove the fan cover (244)
- ◆ Remove the locking ring (326) and take off the fan (321)
- ◆ Loosen the screws (238, 353), remove the washers and take off the heat exchanger (241).
- ◆ Check the o-rings (242), replace them if necessary
- ◆ In order to reach the float, loosen the 2 screws (198) and remove its entire seat.
- ◆ Loosen the screw (196) and remove the float (194)
- ◆ Check the o-ring and replace them if necessary (197)
- ◆ Check the cleanness and the operation of the float. Clean it with compressed air, if necessary.
- ◆ Reinsert the float in its seat (195). Respect the mounting direction of the float.

Replacing the Oil Filter

- ◆ Make sure that the entire used oil is drained
- ◆ Remove the oil filter (d,100)
- ◆ Apply a drop of fresh oil on the seal ring of the new oil filter (d,100)
- ◆ Mount the new oil filter (d,100) and tighten it by hand

Filling in Fresh Oil

- ◆ Keep oil acc. to the table "Oil" ready

NOTE: The amount given in these operating instructions is a guide. The oil sight glass (i,83) indicates the actual amount to be filled in.

Make sure that the oil outlet plug (j,95) is firmly inserted.



CAUTION

Filling oil through the suction connection/gas inlet (a,260) will result in breakage of the vanes (n,22) and destruction of the vacuum pump.

Oil may be filled through the oil fill port only (k,88).

- ◆ Remove the oil fill plug (k,88) in oil
- ◆ Fill in oil
- ◆ Make sure that the level is between the MIN and the MAX-markings of the oil sight glass (i,83)
- ◆ Make sure that the seal ring (89) is inserted into the oil inlet plug (k,88) and undamaged, replace if necessary
- ◆ Firmly reinsert the oil inlet plug (k,88) together with the seal ring (89)

Exhaust Filter

Check during operation

FEZER recommends the use of a filter pressure gauge (available as accessory, see "Accessories"). Without filter pressure gauge the filter resistance shall be assessed on the basis of the drive motor current drawn.

- ◆ Make sure that the vacuum pump is running

Version with filter pressure gauge:

- ◆ Check that the indication of the filter pressure gauge is in the usual range (<0,6 bar)

Version without filter pressure gauge:

- ◆ Check that the drive motor current drawn is in the usual range (see nameplate)

- ◆ Check that the discharge air is free from oil

NOTE: The discharge air will also contain oil if the vacuum pump is operated without interruption for too long a period (see Operation Notes).

Assessment

If

the indication of the filter pressure gauge is in the red field, (>0,6 bar) or

the drive motor (400) draws too much current and/or the pump flow rate has dropped,

then the exhaust filters (l,120) are clogged and must be replaced.

NOTE: Exhaust filters cannot be cleaned successfully. Clogged exhaust filters must be replaced with new ones.

If

the filter pressure gauge indicates a lower pressure than usual,

or

the drive motor draws less current than usual,

the exhaust filters (l,120) can be clogged and must be replaced.

If the discharge air contains oil,

the exhaust filters (l, 120) can be clogged or broken through and, if applicable, must be replaced.

Change of the exhaust filters



WARNING

In case the vacuum pump conveyed gas that was contaminated with foreign materials which are dangerous to health, harmful material can reside in filters.

Danger to health during inspection, cleaning or replacement of filters.

Danger to the environment.

Personal protective equipment must be worn during the handling of contaminated filters.

Contaminated filters are special waste and must be disposed of separately in compliance with applicable regulations

Removing the exhaust filters

- ❖ Make sure that the vacuum pump is shut down and locked against inadvertent start up
- ❖ Prior to disconnecting pipes/lines make sure that the connected pipes/lines are vented to atmospheric pressure
- ❖ Remove the discharge line, if necessary
- ❖ Remove the discharge cover (142) from the oil separator
- ❖ Remove the seal for the separator cover (141), if necessary
- ❖ Remove the distance ring (137)
- ❖ Remove the filter material and the protection screen (136,130)
- ❖ Remove the discharge cover and filter by loosening the screw (134), and remove the lock washer (132)
- ❖ Set down the whole on an even and clean area.
- ❖ To reach the exhaust filters, unscrew the 2 lock screws (126)
- ❖ Remove the 2 lock washers (128) and the plate (115)
- ❖ Remove the exhaust filters (I,120) and the O- rings (121)

Inserting the Exhaust Filters



CAUTION

The non-OEM spares market offers exhaust filters that are geometrically compatible with FEZER-vacuum pumps, but do not feature the high retention capacity of genuine FEZER-exhaust filters and deteriorate the service life and the efficiency of the vacuum pump due to their increased back pressure.

Increased risk of damage to health.

Adverse effect on efficiency and service life.

In order to keep the emission on the lowest possible level and to preserve efficiency and service life only genuine FEZER-exhaust filters shall be used.

- ❖ Remove the O-rings (119) from the filter support (118) and replace them by new ones.
- ❖ Insert the new discharge filters with new O- rings in the filter support (118). Be sure to fit filters as indicated by the arrow at filters.
- ❖ Install the plate such that the guiding line (133) is properly seated on the 2 supports (118, 115)
- ❖ Mount the two lock washers (128) and screw the 2 screws (126)
- ❖ Mount the set support-exhaust filters in the oil separator by guiding them on the filter support (131)
- ❖ Mount the lock washer (132) and screw the nut again (134)
- ❖ Replace the set protection screen-filter material (136, 130)
- ❖ Insert the set protection screen-filter material such that their ports are properly seated in their receptacles in the oil separator
- ❖ Push to the end of the oil separator
- ❖ Make sure that the filter material leans on all sides of the separator
- ❖ Insert the screws (137) in both slots. These ones support the protection screen and the filter material.
- ❖ Check the seal (141) and replace it, if necessary
- ❖ Check the mounted felt (557) mounted in the discharge flange (153) and replace it, if necessary
- ❖ Mount the exhaust cover

NOTE: During operation the exhaust filters get saturated with oil. It is therefore normal that the oil level will drop slightly after replacement of the exhaust filters.

Gas ballast

Check the gas ballast inlet regularly. If the gas ballast doesn't work correctly, disassemble it, clean it and blow it with compressed air

Inlet flange

Check the inlet flange regularly. The maintenance interval of the inlet flange depends on the application. To clean the mesh screen (h,261) at the inlet:

- Remove the upper parts of the inlet flange
- Remove the flange
- Remove the mesh screen (h,261) and clean it with compressed air
- - Check the different seals and replace them if necessary
- - Refit the mesh screen and the inlet flange

Fan cover

Check the fan cover regularly. A bad maintenance of the fan cover will affect the vacuum pump cooling and may lead to overheating of the vacuum pump.

Motor cover

Check the motor cover regularly. A bad maintenance of the motor cover will affect the vacuum pump cooling and may lead to overheating of the vacuum pump

Overhaul



CAUTION

In order to achieve best efficiency and long life the vacuum pump was assembled and adjusted with precisely defined tolerances.

This adjustment will be lost during dismantling of the vacuum pump.

It is therefore strictly recommended that any dismantling of the vacuum pump that is beyond or what is described in this manual shall be done by FEZER service.



CAUTION

Improper work on the vacuum pump put the operating safety at risk.

Risk of explosion!

Approval for operation will be void!

Any dismantling of the vacuum pump that is beyond of what is described in this manual must be done by specially trained FEZER service personnel only.



WARNING

In case the vacuum pump conveyed gas that was contaminated with foreign materials which are dangerous to health, harmful material can reside in oil and condensates.

Danger to health dismantling of the vacuum pump.

Danger to the environment.

Prior to shipping, the vacuum pump must imperatively be decontaminated and the degree of contamination must be documented in a declaration of decontamination ('Declaration of Decontamination') which is available at FEZER service.

FEZER service will only accept vacuum pumps that come with a completely filled in and legally binding signed 'Declaration of Contamination' (form available at FEZER service).

Removal from Service

Temporary Removal from Service

- ◆ Prior to disconnecting pipes/lines make sure that all pipes/lines are vented to atmospheric pressure

Recommissioning



CAUTION

Vanes (n,22) can stick after a long period of standstill.

Risk of vane breakage if the vacuum pump is started with the drive motor.

After longer periods of standstill the vacuum pump shall be turned by hand.

After longer periods of standstill:

- Make sure that the vacuum pump is shut down and locked against inadvertent start up
- Remove the cover around the fan of the drive motor
- Slowly rotate the fan wheel by hand several revolutions in the intended direction of rotation (see stuck on or cast arrow)
- Mount the cover around the fan wheel of the drive motor

If deposits could have gathered in the vacuum pump:

- Flush the vacuum pump (see "Maintenance")

- ◆ Observe the chapter "Installation and Commissioning"

Dismantling and Disposal



WARNING

In case the vacuum pump conveyed gas that was contaminated with harmful foreign material the operating fluid and the exhaust Filter(s) will be contaminated with harmful material.

Harmful material can reside in pores, gaps and internal spaces of the vacuum pump.

Danger to health during dismantling of the vacuum pump.

Danger to the environment.

During dismantling of the vacuum pump personal protective equipment must be worn.

The vacuum pump must be decontaminated prior to disposal.

Prior to shipping, the vacuum pump must imperatively be decontaminated and the degree of contamination must be documented in a declaration of decontamination ('Declaration of Decontamination') which is available at FEZER service.

Dispose of the used oil and condensate according to applicable environmental protection regulations.



CAUTION

Used oil, used exhaust filters and used oil filters are special waste and must be disposed of in compliance with applicable regulations.

- Remove the exhaust filter (l,120) (see 'Maintenance, Exhaust Filter')
- Drain the oil
- Remove the oil filter (d,100)
- Make sure that materials and components to be treated as special waste have been separated from the vacuum pump
- Make sure that the vacuum pump is not contaminated with harmful foreign material
- Dispose of the used oil in compliance with applicable regulations
- Dispose of special waste in compliance with applicable regulations
- Dispose of the vacuum pump as scrap metal

According to the best knowledge at the time of printing of this manual the materials used for the manufacture of the vacuum pump involve no risk.

Troubleshooting



WARNING

Risk of electrical shock, risk of damage to equipment.

Electrical installation work must only be executed by qualified personnel that knows and observes the following regulations:

- IEC 364 or CENELEC HD 384 or DIN VDE 0100, respectively,
- IEC-Report 664 or DIN VDE 0110,
- BGV A2 (VBG 4) or equivalent national accident prevention regulation.



CAUTION

During operation the surface of the vacuum pump may reach temperatures of more than 70°C. Risk of burns!!

Let the vacuum pump cool down prior to a required contact or wear heat protection gloves.

Problem	Possible Cause	Remedy
The vacuum pump does not reach the usual pressure	The vacuum system or suction line is not leak-tight	Check the hose or pipe connections for possible leak
The drive motor draws a too high current (compare with initial value after commissioning)	Contaminated oil (the most common cause)	Drain the oil (see "Maintenance")
Evacuation of the system takes too long	No or not enough oil in the reservoir	Top up oil (see "Maintenance")
	The exhaust filters (l) are partly clogged	Replace the exhaust filters (l) (see "Maintenance")
	The oil filter is partly clogged (the oil flows through the bypass only, the oil does not get filtered any more)	Replace the oil filter (d) (see "Maintenance")
	In case a mesh screen (h) is installed on the suction connection (a): The mesh screen (h) on the suction connection (a) is partly clogged	Clean the mesh screen (h) If cleaning is required too frequently install a filter upstream
	In case an inlet filter is installed on the suction connection (a): The filter on the suction connection (a) is partly clogged	Clean or replace the inlet filter, respectively
	Partial clogging in the suction, discharge or pressure line	Remove the clogging
	Long suction, discharge or pressure line with too small diameter	Use larger diameter
	The valve disk (251) of the inlet non-return valve is stuck in closed or partially open position	Disassemble the inlet, clean the mesh screen (h) and the valve (251-254) as required and reassemble
	The oil tubing is defective or leaking The oil return line is broken	Tighten the connections Replace the connections and/or the tubing (replace with identically dimensioned parts only)
	A shaft seal is leaking	Replace the shaft seal ring (FEZER service)
	The exhaust valve (g) is not properly seated or stuck in partially open position	Disassemble and reassemble the exhaust valve(s) (g) (FEZER service)
	A vane(n) is blocked in the rotor or otherwise damaged	Free the vanes (n) or replace with new ones (FEZER service)

	The radial clearance between the rotor (o) and the cylinder is no longer adequate	Readjust the vacuum pump (FEZER service)
	Internal parts worn or damaged	Repair the vacuum pump (FEZER service)
	<p>The oil return line starts in an area vented to atmospheric pressure. Particularly on small model pumps, a fairly large amount of air is sucked through the oil return line, which may prevent the ultimate pressure from reaching 20 bar abs.</p> <p>In order to exclude this possible cause:</p> <p>squirt oil through the gas discharge/pressure connection (b) into the oil return line. While oil is being sucked in, the ultimate pressure is not affected by the air normally sucked through the oil return line.</p>	
The gas conveyed by the vacuum pump smells displeasing	<p>Process components evaporating under vacuum</p> <p>Readily volatile and thus gaseous components of the oil, e.g. additives, particularly right after an oil change.</p> <p>NOTE: This is no indication of a malfunction of the oil separator. The oil separator is able to retain droplets of oil, however no gaseous components of it</p>	<p>Check the process, if applicable</p> <p>Use a different type of oil, if applicable</p>
The vacuum pump does not start	The drive motor is not supplied with the correct voltage or is overloaded	Supply the drive motor with the correct voltage
	The drive motor starter overload protection is too small or trip level is too low	<p>Compare the trip level of the drive motor starter overload protection with the data on the nameplate</p> <p>Correct if necessary</p> <p>In case of high ambient temperature:</p> <p>Set the trip level of the drive motor starter overload protection 5 percent above the nominal drive motor current</p>
	One of the fuses has blown	Check the fuses
	The connection cable is too small or too long causing a voltage drop at the vacuum pump	Use sufficiently dimensioned cable
	The vacuum pump or the drive motor is blocked	<p>Make sure the drive motor is disconnected from the power supply</p> <p>Remove the fan cover</p> <p>Try to turn the fan by hand</p> <p>If the unit vacuum pump/drive motor is still frozen:</p> <p>Remove the drive motor and check the drive motor and the vacuum pump separately</p> <p>If the vacuum pump is blocked:</p> <p>Repair the vacuum pump (FEZER service)</p>
	The drive motor is defective	Replace the drive motor (FEZER service)
The vacuum pump is blocked	Solid foreign matter has entered the vacuum pump	<p>Repair the vacuum pump (FEZER service)</p> <p>Make sure the suction line is equipped with a mesh screen</p> <p>If necessary additionally provide a filter</p>
	Corrosion in the vacuum pump from remaining condensate	<p>Repair the vacuum pump (FEZER service)</p> <p>Check the process</p> <p>Observe the chapter Installation and Commissioning, Operating Notes, Conveying Condensable Vapours</p>

	The vacuum pump was run in the wrong direction	Repair the vacuum pump (FEZER service) When connecting the vacuum pump make sure the vacuum pump will run in the correct direction (see 'Installation')
	After shutting down the vacuum pump the vacuum system exerted underpressure onto the pump chamber which sucked back excessive oil from the oil separator into the pump chamber When the vacuum pump was restarted too much oil was enclosed between the vanes (n) Oil could not be compressed and thus broke a vane (n)	Repair the vacuum pump (FEZER service) Make sure the vacuum system will not exert underpressure onto the shut-down vacuum pump, if necessary provide an additional shut-off valve or non-return valve
	Condensate ran into the pump chamber When the vacuum pump was restarted too much condensate was enclosed between the vanes (n) Condensate could not be compressed and thus broke a vane (n)	Repair the vacuum pump (FEZER service) Make sure no condensate will enter the vacuum pump, if necessary provide a drip leg and a drain cock Drain condensate regularly
The drive motor is running, but the vacuum pump stands still	The coupling between the drive motor and the vacuum pump is defective	Replace the coupling
The vacuum pump starts, but labours or runs noisily or rattles The drive motor draws a too high current (compare with initial value after commissioning)	Connection(s) in the drive motor terminal box are defective Not all drive motor coils are properly connected The drive motor operates on two phases only	Check the proper connection of the wires against the connection diagram Tighten or replace loose connections
	The vacuum pump runs in the wrong direction	Verification and rectification see 'Installation and Commissioning', correct if necessary
	Standstill over several weeks or months	Let the vacuum pump run warm with inlet closed
	Oil viscosity is too high for the ambient temperature	Use synthetic oil, if necessary use oil of the next lower viscosity class (CAUTION: operation with too low viscosity can cause chatter marks inside the cylinder) Warm up the oil with a heating prior to starting up the vacuum pump or, make sure that the vacuum pump runs in intervals in order not to let it get too cold.
	Improper oil quantity, unsuitable oil type	Use the proper quantity of one of the recommended oils (see 'Oil', Oil change see 'Maintenance')
	No oil change over extended period of time	Perform oil change incl. Flushing (see 'Maintenance')
	The exhaust filters (l) are clogged and appear black from burnt oil	Flush the vacuum pump Replace the oil filter (d) Replace the exhaust filter (l) Fill in new oil (see 'Maintenance') In case the oil life is too short: use oil with better heat resistance (see 'Oil ') or retrofit cooling
	Foreign objects in the vacuum pump Broken vanes (n) Stuck bearings	Repair the vacuum pump (FEZER service)
The vacuum pump runs very noisily	Defective bearings	Repair the vacuum pump (FEZER service)

	Worn coupling element	Replace the coupling element
	Stucked vanes (n)	Repair the vacuum pump (FEZER service) Use only approved oils (see "Oil") and change more frequently
The vacuum pump runs very hot (the oil sump temperature shall not exceed 100°C)	Insufficient air ventilation	Make sure that the cooling of the vacuum pump is not impeded by dust/dirt Clean the fan cowlings, fan wheels, ventilation screens and cooling fins Install the vacuum pump in a narrow space only if sufficient ventilation is ensured On a vacuum pump with oil-cooler: Clean the intermediate spaces of the finned tube
	Ambient temperature too high	Observe the permitted ambient temperatures
	Temperature of the inlet gas too high	Observe the permitted temperatures for the inlet gas
	The exhaust filter(l) is partially clogged	Replace the exhaust filters (l)
	The oil filter is partially clogged (the oil flows through the bypass only, the oil does not get filtered any more)	Replace the oil filter (d) (see "Maintenance")
	Not enough oil in the reservoir	Top up oil
	Oil burnt from overheating	Flush the vacuum pump Replace the oil filter (d) Replace the exhaust filters (l) Fill in new oil (see "Maintenance") In case the oil life is too short: use oil with better heat resistance (see "Oil") or retrofit cooling
	Mains frequency or voltage outside tolerance range	Provide a more stable power supply
	In case a mesh screen (h) is installed on the suction connection (a): The mesh screen (h) on the suction connection (a) is partially clogged	Clean the mesh screen (h) If cleaning is required too frequently install a filter upstream
	In case an inlet air filter is installed on the suction connection (a): The filter on the suction connection (a) is partially clogged	Clean or replace the filter
	Partial clogging in the suction or discharge line	Remove the clogging
	Long suction, discharge or pressure line with too small diameter	Use larger diameter
	The vacuum pump fumes at the exhaust side or expels oil droplets through the outlet The oil level drops	The exhaust filters (l) are not properly seated
The O-rings from the exhaust filters are missing or damaged		Add or replace the O-rings (see "Maintenance")
The exhaust filters (1) show cracks		Replace the exhaust filters (l) (see "Maintenance")

	<p>The exhaust filters (1) are clogged with foreign matter NOTE: The saturation of the exhaust filters with oil is no fault and does not impair the function of the exhaust filters! Oil dropping down from the exhaust filters is returned to the oil circulation.</p>	<p>Replace the exhaust filters (1) (see "Maintenance")</p>
	<p>The oil return valve is clogged</p>	<p>Clean the oil return valve (see "Maintenance, Oil change/Oil Filter, Oil Return Valve cleaning")</p>
	<p>The oil return line is clogged or broken</p>	<p>Repair the oil tubing (FEZER service) Replace a broken oil return line with an identically dimensioned line Fill in new oil</p>
<p>The oil is black</p>	<p>Oil change intervals are too long The oil was overheated</p>	<p>Flush the vacuum pump Replace the oil filter(d) Replace the exhaust filters (1) Fill in new oil (see "Maintenance") In case the oil life is too short: use oil with better heat resistance (see "Oil ") or retrofit cooling</p>
<p>The oil is watery and coloured white</p>	<p>The vacuum pump aspirated water or significant amounts of humidity</p>	<p>Flush the vacuum pump Replace the oil filter(d) Replace the exhaust filters (1) Flush the vacuum pump (see "Maintenance") Modify the operational mode (see "Installation and Commissioning, Operating Notes, Conveying Condensable Vapours")</p>
<p>The oil is resinous and/or sticky</p>	<p>Improper oil type, perhaps in confusion</p>	<p>Flush the vacuum pump Replace the oil filter(d) Replace the exhaust filters (1) Fill in new oil (see "Maintenance") Make sure the proper oil is used for the application</p>
<p>The oil foams</p>	<p>Mixing of incompatible oils</p>	<p>Flush the vacuum pump Replace the oil filter(d) Replace the exhaust filters (1) Fill in new oil (see "Maintenance") Make sure the proper oil is used for the application</p>

Exploded Drawing

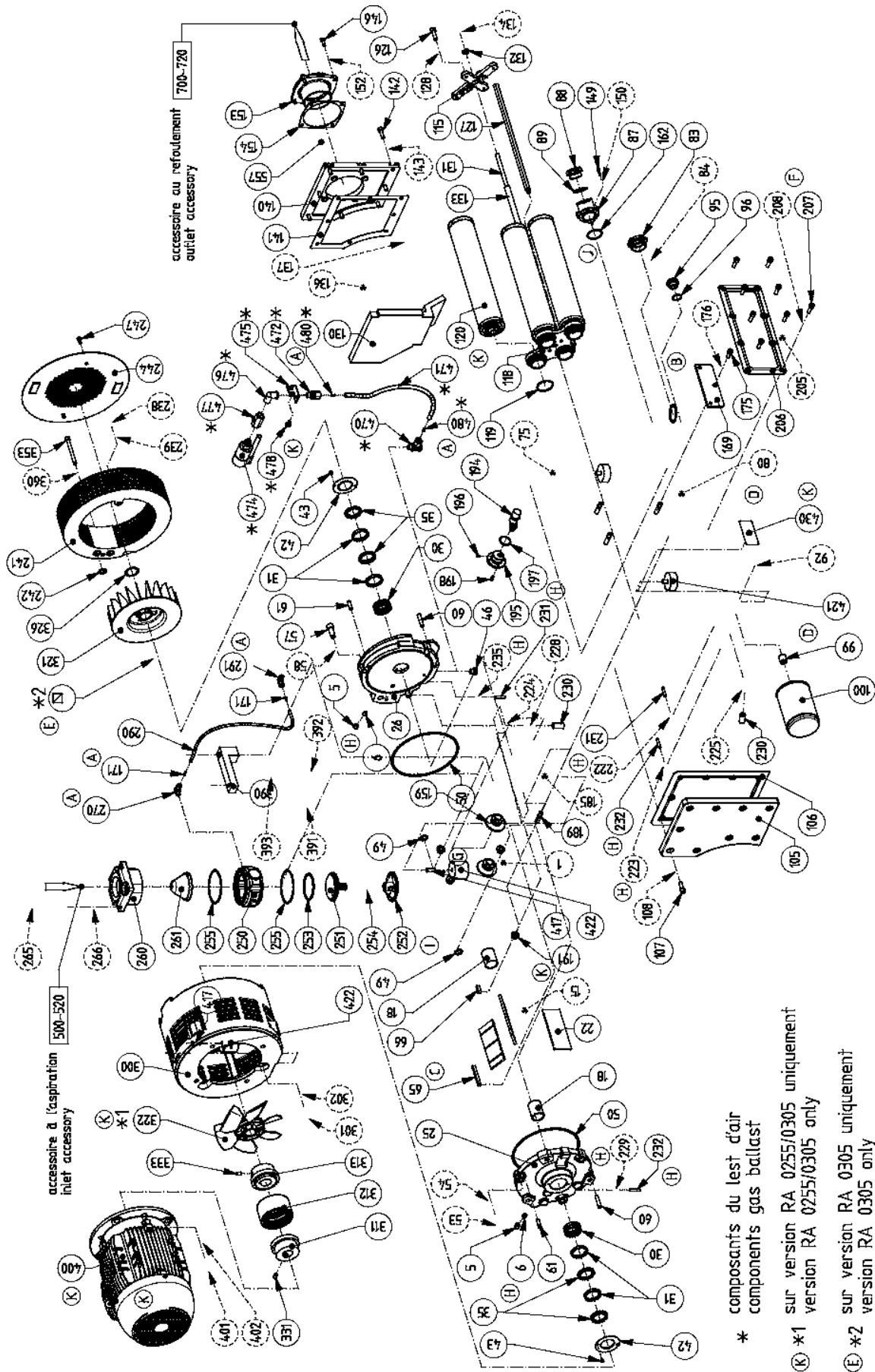

Spare Parts

Note: When ordering spare parts or accessories acc. to the table below please always quote the type ("Type") and the serial no. ("No") of the vacuum pump. This will allow Fezer service to check if the vacuum pump is compatible with a modified or improved part.

The exclusive use of genuine spare parts and consumables is a prerequisite for the proper function of the vacuum pump and for the granting of warranty, guarantee or goodwill.

This parts list applies to a typical configuration of the vacuum pump 0160.3 – 0250.3. Depending on the specific order deviating parts data may apply.

Your point of contact for service and spare parts in Germany:

ALBERT FEZER
MASCHINENFABRIK GMBH
HAUPTSTR. 37-39
D-73730 ESSLINGEN
GERMANY

TEL.: +49 (0) 711/36 009-0
FAX: +49 (0) 711/36 009-40
MAIL: info@fezer.com

Find the up-to-date list of Fezer companies and agencies all over the world on the internet at www.fezer.com.

Pos.	Part for 0160.3	Qt
7	O- ring	1
18	Sleeve	2
22	Vanes	3
30	Needle bearing	2
35	Shaft seal	4
49	O-ring	2
50	O-ring	2
60	Taperpin	4
61	Parallel pin	4
84	Seal	1
84	Oil sight glass seal	1
88	Plug	1
89	Seal	1
89	O-ring	1
95	Drain plug	1
96	O-ring	1
100	Oil filter	1
106	Oil separator seal	1
119	O-ring	4
120	Exhaust filter	4
130	Filter material	1
136	Punched sheet metal	1
141	Seal	1
154	Oil separator cover seal	1
159	Discharge valve	2

162	Seal	1
185	Oil separator seal	1
197	O-ring	1
206	Oil separator seal	1
242	O-ring	2
253	O-ring	1
255	O-ring	2
261	Mesh screen	1
312	Coupling sleeve	1
326	Locking ring	1

Pos.	Part for 0250.3	Qt
7	O- ring	1
18	Sleeve	2
22	Vanes	3
30	Needle bearing	2
35	Shaft seal	4
49	O-ring	2
50	O-ring	2
60	Taperpin	4
61	Parallel pin	4
84	Seal	1
84	Oil sight glass seal	1
88	Plug	1
89	Seal	1
89	O-ring	1
95	Drain plug	1
96	O-ring	1
100	Oil filter	1
106	Oil separator seal	1
119	O-ring	4
120	Exhaust filter	4
130	Filter material	1
136	Punched sheet metal	1
141	Seal	1
154	Oil separator cover seal	1
159	Discharge valve	3
162	Seal	1
185	Oil separator seal	1
197	O-ring	1
206	Oil separator seal	1
242	O-ring	2
253	O-ring	1
255	O-ring	2
261	Mesh screen	1
312	Coupling sleeve	1
326	Locking ring	1

Wearing parts kit

Wearing parts kit	Description
Set of seals	consisting of all necessary seals
Overhaul kit	consisting of set of seals and all wearing parts
Service kit	consisting of oil filter, exhaust filters and o-rings

Accessories

Accessories
Inlet filter upright with paper cartridge
Inlet filter horizontal with paper cartridge
Replacement paper cartridge
Gas ballast, side fan cover
Gas ballast with solenoid valve, side fan cover
Silencer
Exhaust filters pressure gauge
Vacuum regulating unit, connection G 1 _{1/2}
Motor safety switch: Adjustment range 6,0-10,0 A, 400V, 50 Hz
Motor safety switch: Adjustment range 10,0-16,0 A, 400V, 50 Hz
Motor safety switch: Adjustment range 16,0-25,0 A, 230V, 50 Hz
Motor safety switch: Adjustment range 25,0-32,0 A, 230V, 50 Hz

öl

Denomination	VM 032	VM 068	VM 100	VE 101	VMH 100	VS 100
ISO-VG	32	68	100	100	100	100
Base	Mineral oil	Mineral oil	Mineral oil	Synthetical oil	Mineral oil	PAO
Density [g/cm ³]	0,872	0,884	0,888	0,96	0,87	0,85
Ambienttemperature range	-5	0 ... 12	12 ... 30	0 ... 40	12 ... 30	0 ... 40
Kinematicviscosityat 40°C [mm ² /s]	30	68	110	95	94	103
Kinematicviscosityat 100°C [mm ² /s]	5	8,5	11,5	9,5	-	14
Flashpoint [°C]	225	235	260	255	264	265
Pourpoint [°C]	- 15	- 15	- 15	- 30	- 15	- 48
Note	Ambient temperature lower than 0 °C				Ultimate pressure application	Food application
Filling quantity, approx. [l]	6,5					

